

CHOICE OF FLOW PATTERN

LL-1 - One-Way Pattern

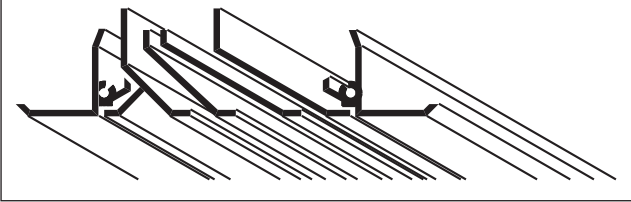

LL-2 - Two-Way Pattern

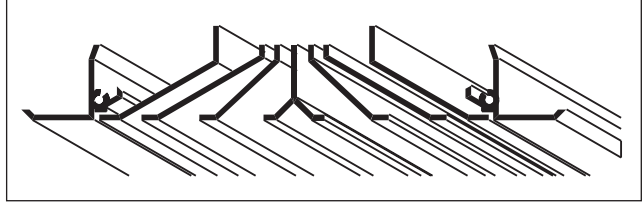

AVAILABLE WIDTHS

LL-1 - One-Way Pattern

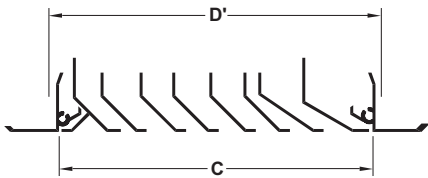

| | |
|----------------------|--|
| Nominal Duct Width | 3½, 4¼, 5, 5¾, 6½, 8, 9½, 11¼ |
| Actual Duct Width D' | 3 ⁵ / ₈ , 4 ² / ₈ , 5 ¹ / ₈ , 5 ⁷ / ₈ , 6 ⁵ / ₈ , 8 ¹ / ₈ , 9 ⁵ / ₈ , 11 ⁷ / ₈ |
| Face Width C | 3 ³ / ₈ , 4 ¹ / ₈ , 4 ⁷ / ₈ , 5 ⁵ / ₈ , 6 ³ / ₈ , 7 ⁷ / ₈ , 9 ³ / ₈ , 11 ⁵ / ₈ |

LL-2 - Two-Way Pattern

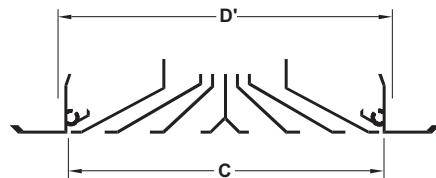

| | |
|----------------------|---|
| Nominal Duct Width | 6¼, 7¼, 9¼, 10¼, 12¼ |
| Actual Duct Width D' | 6 ³ / ₈ , 7 ⁷ / ₈ , 9 ³ / ₈ , 10 ⁷ / ₈ , 12 ³ / ₈ |
| Face Width C | 6 ¹ / ₈ , 7 ⁵ / ₈ , 9 ¹ / ₈ , 10 ⁵ / ₈ , 12 ¹ / ₈ |

Frame Types 1A & 1B

- Surface Flange, Duct Mount

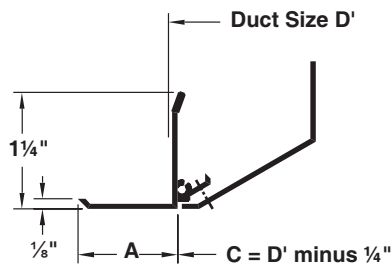

| Type | A |
|------|---|
| 1A | ½ |
| 1B | 1 |

Frame Type 2

- No Flange, Duct Mount

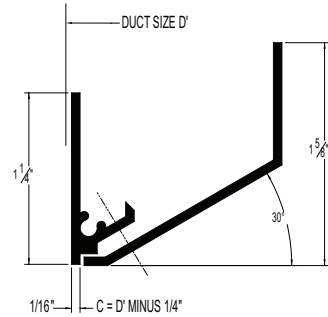

END FABRICATION

X-X End Borders



| | |
|-------|---------|
| Frame | O |
| 1A | D + ¾ |
| 1B | D + 1¾ |
| Frame | O |
| 2 | D - 1/8 |

Y-Y End Borders



X-Y End Borders

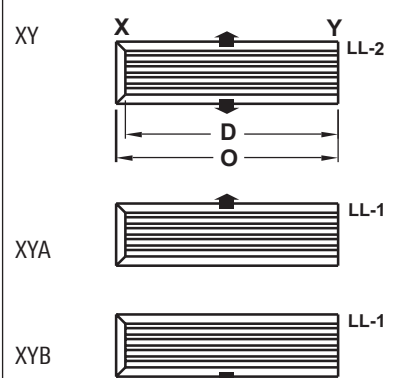

| | | | |
|-------|---------|-------|----------|
| Frame | O | Frame | O |
| 1A | D + 3/8 | 2 | D - 1/16 |
| 1B | D + 7/8 | | |

All dimensions are in inches