

FlowBar™ Architectural Ceiling Diffusers Aluminum • FlowBar Linear

Models: FL-10 • 1" Slot FL-15 • 1 1/2" Slot FL-20 • 2" Slot
 FL-25 • 2 1/2" Slot FL-30 • 3" Slot

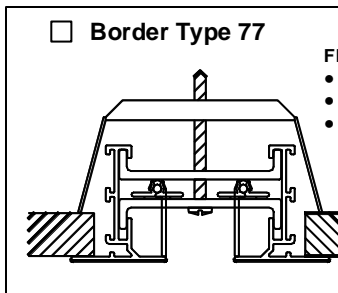
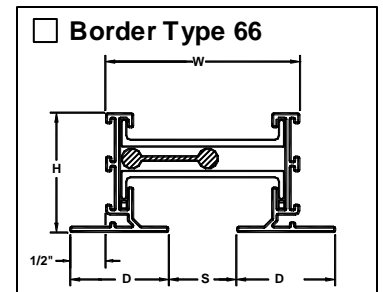
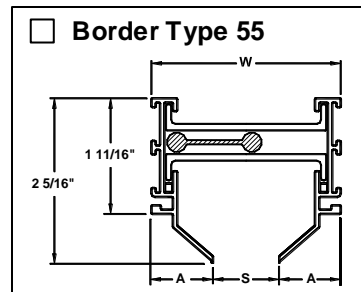
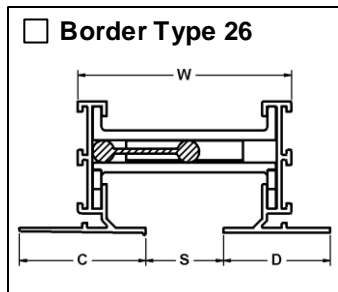
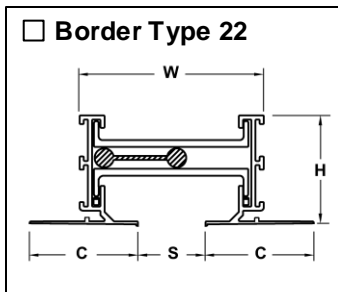
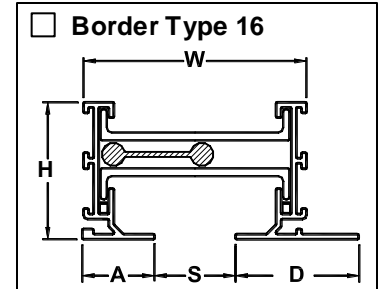
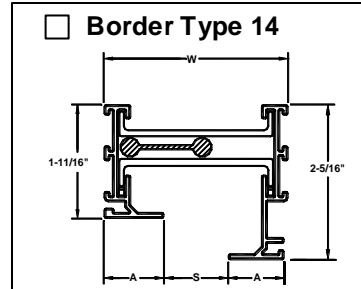
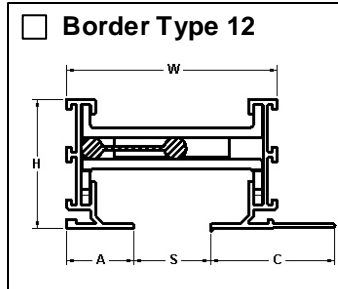
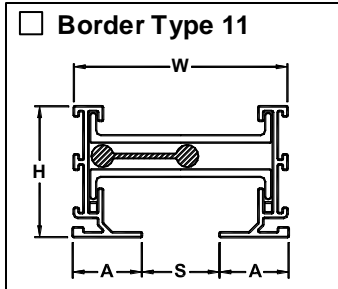
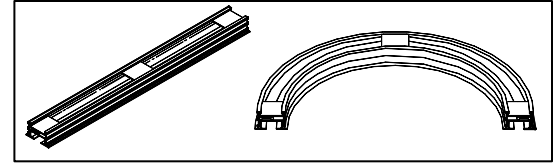

FlowBar Concealed Fastening

- Border Type 66
- Mounting brackets
- #10 x 2 1/2 screws

-
-
-
-

FlowBar Model	Ceiling Opening Width		
	1-Slot	2-Slot	2-Slot
FL-10	3"	5 1/2"	6 3/8"
FL-15	4"	7 1/2"	8 3/8"
FL-20	5"	9 1/2"	10 3/8"
FL-25	6"	11 1/2"	12 3/8"
FL-30	7"	13 1/2"	14 3/8"

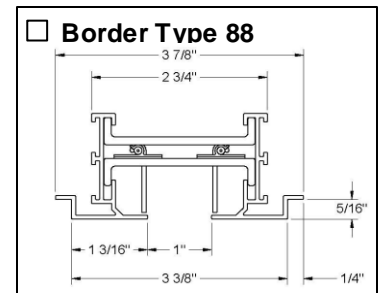

Continuous length version of FL-TZ
 FL-10 1-slot and FL-10 2CRA only

Slot Width Option

Model	S Slot Width	W Width	A Border Width	C Border Width	D Border Width	H Height
<input type="checkbox"/> FL-10	1	2 3/4	7/8	1 5/8	1 3/8	1 11/16
<input type="checkbox"/> FL-15	1 1/2	3 3/4	1 1/8	1 7/8	1 5/8	1 11/16
<input type="checkbox"/> FL-20	2	4 3/4	1 3/8	2 1/8	1 7/8	1 11/16
<input type="checkbox"/> FL-25	2 1/2	5 3/4	1 5/8	2 1/8	2 1/8	2 5/16
<input type="checkbox"/> FL-30	3	6 3/4	1 7/8	2 3/8	2 3/8	2 5/16

Two Slot Option

2CRA **2CRN**

Model	S Slot Width	B Border Width	W Width	WN Width
<input type="checkbox"/> FL-10	1	1 7/16	5 3/16	6 1/16
<input type="checkbox"/> FL-15	1 1/2	1 15/16	7 3/16	8 1/16
<input type="checkbox"/> FL-20	2	2 7/16	9 3/16	10 1/16
<input type="checkbox"/> FL-25	2 1/2	2 15/16	11 3/16	12 1/16
<input type="checkbox"/> FL-30	3	3 7/16	13 3/16	14 1/16

Pattern Controller Option

High Throw (HT) Jet Throw (JT)

Optional FlowBar Cross

Model

- FBC-10
- FBC-15
- FBC-20
- FBC-25
- FBC-30

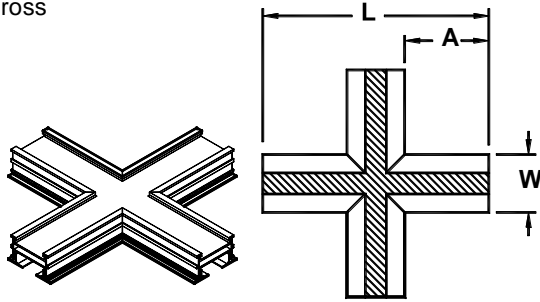

No. of Slots	Slot Width	L	Border Type 11		Border Type 66	
			W	A	W	A
1	1	14 3/4	2 3/4	6	3 3/4	5 1/2
	1 1/2	15 3/4	3 3/4	6	4 3/4	5 1/2
	2	16 3/4	4 3/4	6	5 3/4	5 1/2
	2 1/2	17 3/4	5 3/4	6	6 3/4	5 1/2
	3	18 3/4	6 3/4	6	7 3/4	5 1/2

Note: Slot is blanked off

Optional FlowBar Mitered Corner

Model

- FBMC-10
- FBMC-15
- FBMC-20
- FBMC-25
- FBMC-30

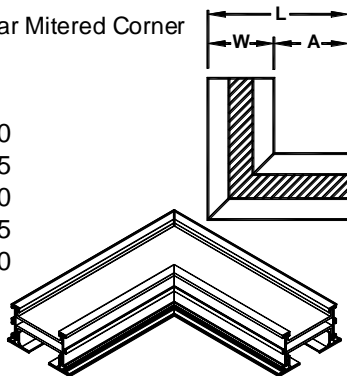

No. of Slots	Slot Width	Border Type 11			Border Type 66			Border Type 22		
		L	W	A	L	W	A	L	W	A
1	1	8 3/4	2 3/4	6	9 1/4	3 3/4	5 1/2	9 1/2	4 1/4	5 1/4
	1 1/2	9 3/4	3 3/4	6	10 1/4	4 3/4	5 1/2	10 1/2	5 1/4	5 1/4
	2	10 3/4	4 3/4	6	11 1/4	5 3/4	5 1/2	11 1/2	6 1/4	5 1/4
	2 1/2	11 3/4	5 3/4	6	12 1/4	6 3/4	5 1/2	12 1/4	6 3/4	5 1/2
	3	12 3/4	6 3/4	6	13 1/4	7 3/4	5 1/2	13 1/4	7 3/4	5 1/2
2	1	11 3/16	5 3/16	6	11 11/16	6 3/16	5 1/2	N/A	N/A	N/A
	1 1/2	13 3/16	7 3/16	6	13 11/16	8 3/16	5 1/2	N/A	N/A	N/A
	2	15 3/16	9 3/16	6	15 11/16	10 3/16	5 1/2	N/A	N/A	N/A
	2 1/2	17 3/16	11 3/16	6	17 11/16	12 3/16	5 1/2	N/A	N/A	N/A
	3	19 3/16	13 3/16	6	19 11/16	14 3/16	5 1/2	N/A	N/A	N/A

Note: Slot is blanked off

Optional Blank-Offs

Model

- FBBO-10
- FBBO-15
- FBBO-20
- FBBO-25
- FBBO-30

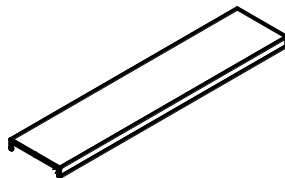

Note: Blankoffs are painted black.
Not available for curved FlowBar.
Provided in 72" lengths. Field cut to length.

CFB – Concealed Fastener Mounting Bracket

Supplied with border 77.
Available separately.

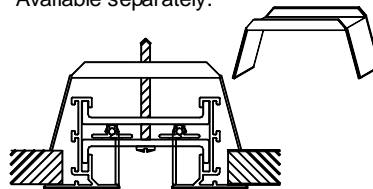

NS – Sound Stop

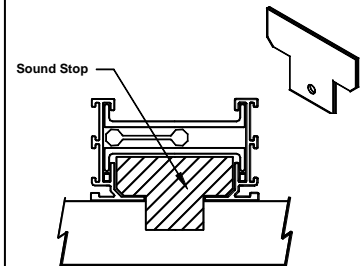

Optional Return Hood/Light Shield

Model

- FBR-10
- FBR-15
- FBR-20
- FBR-25
- FBR-30

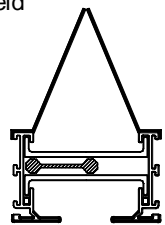

Uninsulated

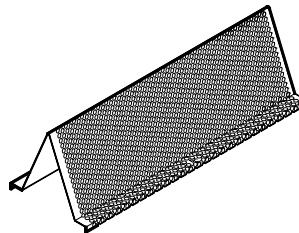

Model

- FBRI-10
- FBRI-15
- FBRI-20
- FBRI-25
- FBRI-30

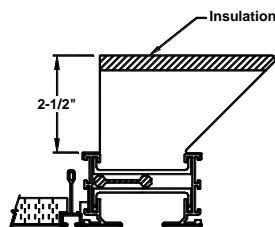

Insulated

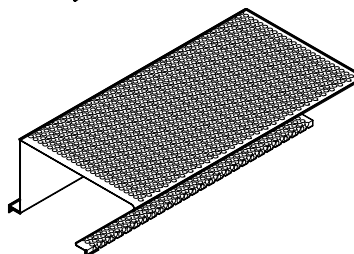

Number of Slots	Slot Width	H (Height)
1	1	3 3/8
	1 1/2	3 3/8
	2	3 3/8
	2 1/2	3 3/8
	3	3 3/8
2	1	2 1/8
	1 1/2	3 1/8
	2	4 1/8
	2 1/2	5 1/8
	3	6 1/8

Note: Return Hoods are 51% free area. Finish is #84 black.

Hanger & Mounting Clips Check if provided.

UHC – Upper Hanger Clip

Suspends the FlowBar assembly from the ceiling structure using standard hanger wire.

USH – Upper Support Hanger

Suspends one side of the FlowBar assembly from the ceiling structure.

SC1 – Spline Clip

Support Border Type 11 on Bolt-Slot type suspension systems.

SS1 – Spline Support Clip (field formed)

Integrates standard drop “Tees” with FlowBar assembly.

SS1 – Connector Clip (as shipped)

Adjoins multiple sections of FlowBar.

H1 – Hard Ceiling Clip

Used for mounting Border Types 66 or 16 with standard 5/8” gyp board.

H2 – Hard Ceiling Clip

Used for mounting Border Types 11 or 16 with standard 5/8” gyp board.

H3 – Hard Ceiling Clip

Used to mount short side of Border Type 14 with standard 5/8” gyp board.

H3 – Hard Ceiling Clip

Can be used to mount Border Type 22 with standard 5/8” gyp board.

H3 – Hard Ceiling Clip

Can be used to mount Border Type 55 with standard 5/8” gyp board.

H4 – Hard Ceiling Clip

Mounts the long side of assembly with Border Type 14 border for 5/8” gyp board.

H5 – Hard Ceiling Clip

Used to mount Border 22 to 1/2” gyp board.

WC2 – Wall Clip

Mounts Border Types 11, 66, or 16 away from a wall when a reveal is required. This reveal can be used as a return air slot.

WC3 – Wall Clip

Mounts Border Types 11 or 16 flush to a wall.

WC4 – Wall Clip

Used for flush mounting Border Types 66 or 16 to a wall.

End Fabrication Check if provided.

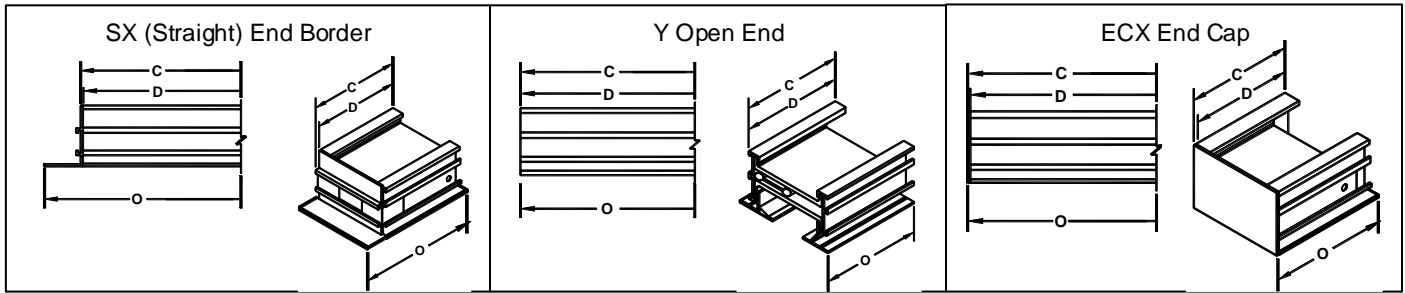

Border Type	Slot Width	SXX		SXY		YY		ECXX		ECXY	
		C	O	C	O	C	O	C	O	C	O
		1	D+3/8	D+2 1/8	D+3/16	D+1 1/16	D	D	D+1/8	D+1/8	D+1/16
11	11/2	D+3/8	D+2 1/8	D+3/16	D+1 1/16	D	D	D+1/8	D+1/8	D+1/16	D+1/16
	2	D+3/8	D+2 1/8	D+3/16	D+1 1/16	D	D	D+1/8	D+1/8	D+1/16	D+1/16
	2 1/2	D+3/8	D+2 1/8	D+3/16	D+1 1/16	D	D	D+1/8	D+1/8	D+1/16	D+1/16
	3	D+3/8	D+2 1/8	D+3/16	D+1 1/16	D	D	D+1/8	D+1/8	D+1/16	D+1/16
22/55	1	NA	NA	NA	NA	D	D	D+1/8	D+1/8	D+1/16	D+1/16
	1 1/2	NA	NA	NA	NA	D	D	D+1/8	D+1/8	D+1/16	D+1/16
	2	NA	NA	NA	NA	D	D	D+1/8	D+1/8	D+1/16	D+1/16
	2 1/2	NA	NA	NA	NA	D	D	D+1/8	D+1/8	D+1/16	D+1/16
	3	NA	NA	NA	NA	D	D	D+1/8	D+1/8	D+1/16	D+1/16
66/77	1	D+3/8	D+2 1/8	D+3/16	D+1 1/16	D	D	D+1/8	D+1/8	D+1/16	D+1/16
	1 1/2	D+3/8	D+2 1/8	D+3/16	D+1 1/16	D	D	D+1/8	D+1/8	D+1/16	D+1/16
	2	D+3/8	D+2 1/8	D+3/16	D+1 1/16	D	D	D+1/8	D+1/8	D+1/16	D+1/16
	2 1/2	D+3/8	D+2 1/8	D+3/16	D+1 1/16	D	D	D+1/8	D+1/8	D+1/16	D+1/16
	3	D+3/8	D+2 1/8	D+3/16	D+1 1/16	D	D	D+1/8	D+1/8	D+1/16	D+1/16
14	1	NA	NA	NA	NA	D	D	D+1/8	D+1/8	D+1/16	D+1/16
	1 1/2	NA	NA	NA	NA	D	D	D+1/8	D+1/8	D+1/16	D+1/16
	2	NA	NA	NA	NA	D	D	D+1/8	D+1/8	D+1/16	D+1/16
	2 1/2	NA	NA	NA	NA	D	D	D+1/8	D+1/8	D+1/16	D+1/16
	3	NA	NA	NA	NA	D	D	D+1/8	D+1/8	D+1/16	D+1/16
16	1	D+3/8	D+2 1/8	D+3/16	D+1 1/16	D	D	D+1/8	D+1/8	D+1/16	D+1/16
	1 1/2	D+3/8	D+2 1/8	D+3/16	D+1 1/16	D	D	D+1/8	D+1/8	D+1/16	D+1/16
	2	D+3/8	D+2 1/8	D+3/16	D+1 1/16	D	D	D+1/8	D+1/8	D+1/16	D+1/16
	2 1/2	D+3/8	D+2 1/8	D+3/16	D+1 1/16	D	D	D+1/8	D+1/8	D+1/16	D+1/16
	3	D+3/8	D+2 1/8	D+3/16	D+1 1/16	D	D	D+1/8	D+1/8	D+1/16	D+1/16

Dimensions in Inches, D = ordered or specified length, (NA) indicates not available

Clip Usage Chart

Code	Application	Border									
		11	12	14	16	22	26	55	66	77	FBMC
H1	SURF MNT 5/8" GYP	✓	✓		✓		✓		✓		✓
H2	FLUSH MNT 5/8" GYP	✓	✓	✓	✓					✓	✓
H3	TAPE & SPACKLE 5/8" GYP	✓	✓	✓	✓	✓	✓	✓	✓		✓
H4	OFFSET CONCEAL 5/8" GYP			✓							✓
H5	TAPE & SPACKLE 1/2" GYP		✓			✓	✓	✓			✓
SC1	NT GRID	✓	✓	✓	✓		✓		✓		✓
SS1	JOINER	✓	✓	✓	✓	✓	✓	✓	✓	✓	✓
UHC	WIRE HANGING (1-SLOT FL-10, FL-15 & FL-20 ONLY)	✓	✓		✓		✓		✓		✓
USH	WIRE HANGING	✓	✓							✓	✓
WC2	WALL REVEAL	✓	✓	✓	✓		✓		✓	✓	✓
WC3	WALL FLUSH	✓	✓	✓	✓						✓
WC4	WALL FLUSH				✓		✓			✓	✓

General Description

- Continuous length segments are furnished in 72" or optional 144". Spline clips are furnished for joining segments.
- The number and length of non-maximum segments are determined by the factory.
- All borders except 2 and 5 are #26 white border face, black interior surfaces
- Borders 2 and 5 are #84 black, all interior surfaces are black.
- Pattern controllers change direction of the air flow. Maximum length is 24".
- Diffuser material is extruded aluminum.
- Assembled one slot unit weighs approximately 1 lb/ft
- Model FBPI endcaps not insulated

This submittal is meant to demonstrate general dimensions of this product. The drawings are not meant to detail every aspect of the product. Drawings are not to scale.

Titus reserves the right to make changes without written notice.