

Filter Bar Return • Heavy Duty Gym • Steel

Models: 30RFL • 0° Deflection • Long Blades • 3/8" Spacing
 30RFS • 0° Deflection • Short Blades • 3/8" Spacing

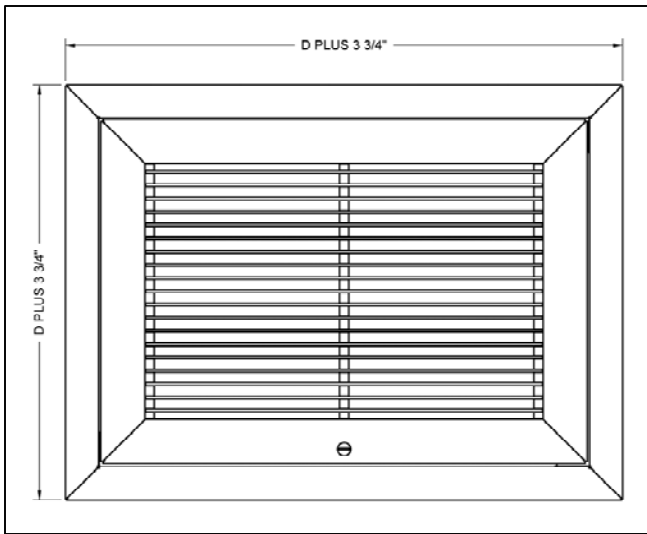

Face View:
 Border Type 1 (Surface Mount)

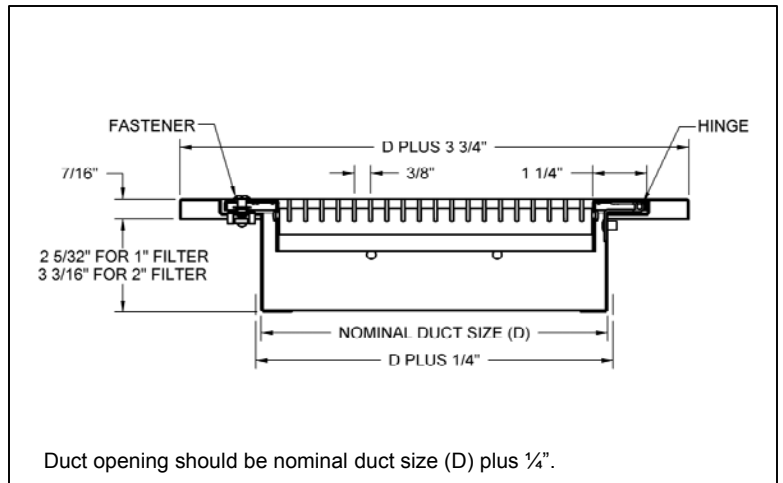

Side Cross-Sectional View:
 Border Type 1 (Surface Mount)

Hinge Location Options:

- Hinged Top
- Hinged Left
- Hinged Right
- Hinged Bottom
- No Hinge

Finish Options:

- Standard Finish: #26 White
- Other Finish: _____

Fastening Options:

- Quarter-Turn Fastener (standard)
- Knurled Knob (optional)

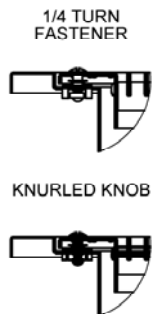

Available Sizes: 6" x 6" to 48" x 24" in one-inch increments. Fractional and oversize filter grilles are not available.
 Maximum size for border type 3 is module size minus 4".

All dimensions are in inches.

General Description

- Series 30 heavy duty filter grilles feature louvers spaced 3/8" apart.
- 30 series models are available in common filter sizes. 1" thick filters may be purchased from hardware stores for the most common sizes.
- Blade deflection angle is 0°.
- Quarter turn fasteners are standard to make filter access easy.
- Knurled knob fastener available as option
- All dimensions are ± 1/16".
- Filters by others
- Dimensions are the same for border type 1 (surface mount) and border type 3 (lay-in T-bar)