

Minimum Security Diffuser Steel • Louvered Core • Lattice Face

Model: MSG-MTDC • 1, 2, 3 or 4 Way Deflection

21 mm square holes on 25 mm centers (standard)

8 mm diameter holes on 11 mm staggered centers (optional)

Screw Hole Location Per Side

Neck Size	Location and Number of Holes
152	One hole at center line
229 to 457	Two holes 76 mm from edge
533 to 610	Three holes equally spaced

Face Gauge: 12 gauge (standard), 10 gauge, 14 gauge
 Note: Available in sizes 152 x 152 through 610 x 610 in 76 mm increments only.

Optional Neck Sleeve

18 Gauge steel sleeve
 14 Gauge steel sleeve
 12 Gauge steel sleeve

Optional Angle Mounting

38 x 38 x 3 steel sleeve angle frame for field welding in place

38 x 38 x 3 steel angles shipped loose for field welding in place on the long side of the sleeve

38 x 38 x 3 steel rear angle frame with weld nuts

Other _____

Damper

Duct mounted steel opposed blade damper (shipped loose)

Other

Border only – back pan and face with no core

Other _____

Finishes

#26 White (Standard)

#04 Mill













#20 Envirotherm • Enamel to match sample

#21 Envirothane • Epoxy to match sample

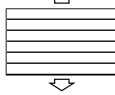
Other _____

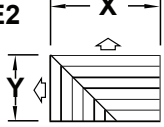
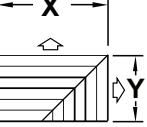
Options & Accessories

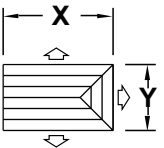
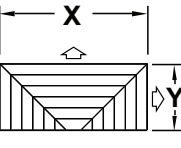
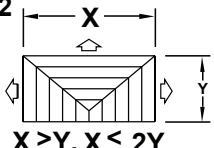
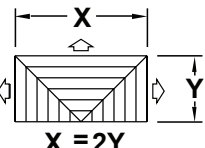
Optional Patterns

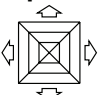
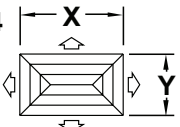
 1 Way	<input type="checkbox"/> S1 Square 	<input type="checkbox"/> A1 	<input type="checkbox"/> B1 
 2 Way	<input type="checkbox"/> A2 	<input type="checkbox"/> S2 Square 	<input type="checkbox"/> B2 
 2 Way Corner	<input type="checkbox"/> E2 	<input type="checkbox"/> F2 	<input type="checkbox"/> G2 Square 
 3 Way	<input type="checkbox"/> A3  $X \geq Y$	<input type="checkbox"/> E3  $X > 2Y$	<p>For A3, $X \geq Y$ For A3-2, $X > Y, X < 2Y$ For B3, $X = 2Y$ For E3, $X > 2Y$</p> <p>* Dimensions X and Y shown here are the proportions of available rectangular duct sizes. Duct sizes are available in 76 mm increments. Dimension X is always the longer dimension for each core option.</p>
<input type="checkbox"/> A3-2  $X > Y, X < 2Y$	<input type="checkbox"/> B3  $X = 2Y$		
 4 Way	<input type="checkbox"/> A4 Square 	<input type="checkbox"/> B4 	

Note: Dimension is determined by factory.

Removing Center Core

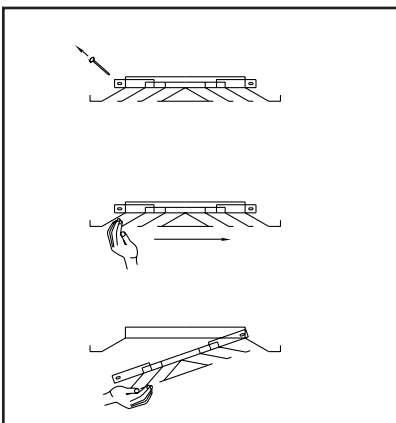

Standard Finish: #26 White

General Description

• Typically used in areas of constant supervision or lobbies and entry ways. The MSG-MTDC is designed where minimum security is still necessary, and maximum performance is required. This ceiling diffuser assembly utilizes the often specified TITUS® TDC diffuser with a heavy gauge steel lattice grille field attached to the face of the diffuser.

Construction Detail

- Face plate: 12 gauge steel with 21 mm square holes and 5 mm fret bars.
- Louvered diffuser: TITUS® model MTDC border type 1 (surface mount) with 1, 2, 3 or 4 way blow pattern.
- Screw holes provided in face plate. Tamper proof screws provided by others.



Note: This submittal is meant to demonstrate general dimensions of this product. The drawing on this submittal are not meant to detail every aspect of the product with exactness. Drawings are not to scale. TITUS reserves the right to make changes without written notice.

MSG-13.0-S

605 Shiloh Road • Plano, Texas 75074 • 972-212-4800